

A-A (1:2)

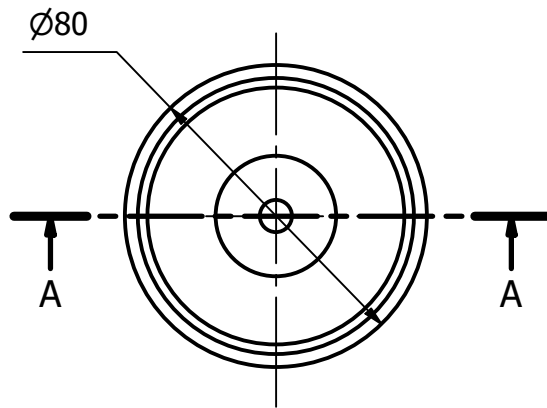
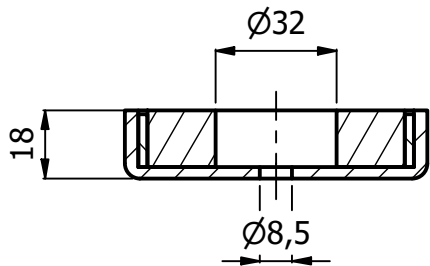

Rev.	Descrizione modifiche	Data	Firma

Disegnato M.D.	Data 29/08/2023	Materiale Ferrite	Trattamento Zincato	Tolleranza +/- 0.2	Unità mm
-------------------	--------------------	----------------------	------------------------	-----------------------	-------------

**ITALFIT magneti**

Via Comelli, 39  
33034 Fagagna (Ud)  
Tel 0432/801675 Fax 0432/810197  
P.IVA e C.F. 02610340305

Descrizione

Sistema magnetico in ferrite con foro passante (N+S)

Codice

SM03.3FE000.8018

Scala

1 : 2

Formato

A4